

**INFLIBNET**

# Newsletter



ISSN : 0971- 9849

Vol. 20, No.2 ( April to June 2013)

**Building the State-of-the-Art  
IT Infrastructure for  
ICT enabled Higher Educational Institutions**

**Manoj Kumar K, Scientist-D (CS) and Head, NQC**

Editorial Board

**Dr. Jagdish Arora**

**SOUL Helpline**

Tel. : +91-79-23268300

**N-LIST (E-resources for College)**

<http://nlist.inflibnet.ac.in>

**INFLIBNET Blog**

<http://www.inflibnet.ac.in/blog>

**INFLIBNET Forum**

<http://www.inflibnet.ac.in/forum>

**INFLIBNET Wiki**

<http://www.inflibnet.ac.in/wiki>

**INFLIBNET Chat**

<http://www.inflibnet.ac.in/chat>

# Contents

- 1. From the Director's Desk**
- 3. INFLIBNET Regional Training Programme on Library Automation**  

INFLIBNET Regional Training Programme on Library Automation, University of Kashmir, Srinagar, 18<sup>th</sup>-22<sup>nd</sup> June, 2013
- 4. Onsite / In-house Training Programme on SOUL 2.0**  

Two-day in-house Training Programme on SOUL 2.0, T. C. College, Baramati, Pune, 12<sup>th</sup>-13<sup>th</sup> April, 2013
- 5. MoU signed with Universities for Shodhganga and User Awareness Programme on Shodhganga**  

Signing of MoU on Shodhganga, Hemchandracharya North Gujarat University, Patan, 12<sup>th</sup> April, 2013

User Awareness programme on Shodhganga, Manonmaniam Sundaranar University, Tirunelveli, 14<sup>th</sup> May, 2013

User Awareness programme on Shodhganga, S. N.D.T. Women's University, Mumbai, 25<sup>th</sup> June, 2013
- 8. INFLIBNET's New Initiative: A-View Virtual Classroom**
- 9. Governing Board meeting at INFLIBNET Centre**
- 10. Schedule of forthcoming Workshops/Trainings**
- 11. Visitors**
- 12. Article**
- 20. New Appointment**
- 21. INFLIBNET in Regional News**

**Dr Jagdish Arora**  
Director



## From the Director's Desk

Settling down into the new campus of INFLIBNET Centre at Infocity, Gandhinagar was trying and bumpy experience for staff and scientists of the Centre. When we moved into the campus in January 2013, the Centre did not even have basic amenities like telephones, Fax and Internet connectivity. Even electrical outlets for computers and other devices were limited. However, thanks to the consistent perseverance of our scientists and cooperation of concerned agencies, we have finally come out of testing times and are settling down to take up the serious business of serving the academic community. International CALIBER 2013 was the first formal event organized at on the new premises of INFLIBNET Centre, Gandhinagar.

This quarter of the year kept us busy in putting the infrastructural facilities in place, getting them purchased using laid-down procedures and practices and getting them installed. While preparing ourselves for the visit of the UGC's Expert Committee lead by Prof. Goverdhan Mehta to evaluate performance of all IUCs including INFLIBNET Centre, we got our Meeting Rooms and Board Rooms readied will all necessary ICT infrastructure.

The Centre organized a number of events and programme during this quarter. IRTPLA Training programme was organized in University of Kashmir, Srinagar in June 2013 and a two-day In-house Training Programme on SOUL 2.0 was organized at T C College, Baramati, Pune.

Shodhganga: a repository of Indian Theses and Dissertations, developed and managed by the INFLIBNET Centre grew both in terms of number of theses deposited in it as well as number of universities who signed MoU with the INFLIBNET Centre. As on 30<sup>th</sup> June, 2013, 121 universities have signed MoU (including nine universities during this quarter) with the INFLIBNET Centre and number of theses deposited in the repository has grown to more than 7,700. Two User Awareness Programmes on Shodhganga were organized during the quarter, one at Manonmaniam Sundaranar University, Tirunelveli and other at SNTD Women University, Mumbai.

I am happy to inform that the Centre is given a monthly slot by A View (Amrita Virtual Interactive e Learning World) to address its users on services and activities provided by us and resolve problems and issues that the users of our services may have. The programmes delivered on A View are being received very well by the user community.

Now that the Centre has adequate physical infrastructural facilities, it is time for us to go on full throttle on our activities and services related to human resources development, i.e. training programmes and workshops. The Centre has planned 9 events including workshop and training programmes in next six months that are being announced in this newsletter.

( Cont. from page no. 1 )

The Article of the quarter entitled “**Building the State-of-the-Art IT Infrastructure for ICT enabled Higher Educational Institutions**” is authored by Mr. Manoj Kumar K., Scientist D (CS), INFLIBNET Centre. Mr. Manoj Kumar talks about laying of Fiber-optic based high speed network at the new campus of INFLIBNET Centre, along with video conferencing facility, IP telephony, Intercom system, Public Address System (PAS), electronic surveillance system, etc. I am sure that the article will be of great help to universities in planning their network requirements.



(Jagdish Arora)



# INFLIBNET Regional Training Programme on Library Automation

## INFLIBNET Regional Training Programme on Library Automation, University of Kashmir, Srinagar, 18<sup>th</sup>-22<sup>nd</sup> June, 2013

The Centre organised five-day Regional Training Programme on Library Automation (IRTPLA) in collaboration with Allama Iqbal Library, University of Kashmir, Srinagar from 18<sup>th</sup>- 22<sup>nd</sup> June 2013 at Allama Iqbal Library, University of Kashmir. The training programme was inaugurated by Prof. Talat Ahmad, Hon'ble Vice Chancellor, in presence of other dignitaries namely, Prof. Zafar Reshi, Registrar, Prof. G Mustafa Shah, Dean, College Development Council, University of Kashmir. Dr. Abdul Majid Baba, University Librarian delivered the welcome address and briefed about various functions and initiatives taken by INFLIBNET

Centre. Prof. Talat Ahmad, Hon'ble Vice Chancellor, in his inaugural speech, stressed upon computer based access to information and appreciated Allama Iqbal Library for providing various ICT-based facilities and services to its user community. He further congratulated the INFLIBNET Centre and University Librarian for organizing such events from time to time. Prof. Zafar Reshi, Registrar, in his speech, appreciated for organising such type of training programmes for automating the libraries, as automation of the libraries is the need of the hour in order to retrieve specific information from huge information resources available in a library. Prof. G Mustafa Shah, Dean, College Development Council appreciated the training programme and requested Hon'ble Vice Chancellor to organize such training programmes also for B.Ed. colleges of Kashmir.



*Shri Swapnil Patel and Shri Divyakant Vaghela, Scientists B (CS), INFLIBNET Centre along with the Participants of the IRTPLA Programme at Srinagar*

The technical sessions started with presentation on “INFLIBNET Centre Activities and Services” by Shri Swapnil P. Patel & followed by another presentation on “SOUL 2.0 Overview” by Shri Divyakant Rajnikant Vaghela. Demonstrations on modules of SOUL 2.0 were given by Shri Divyakant Vaghela & Shri Swapnil Patel and on installation and Backup of SOUL 2.0 by Shri Neeraj Kumar, Regional SOUL Technical Assistant and resource person from INFLIBNET Centre. Theoretical lectures were followed by “hands-on” practice on the same modules by the participants. All the practical sessions of the INFLIBNET Regional Training Programme involved intensive discussions and interactions on various pros and cons of SOUL software between participants and the resource persons. Around 35 library professionals including librarians with working knowledge in computers from universities, colleges and other institutes of Kashmir participated in this programme.

On the valedictory day, Dr. Abdul Majid Baba thanked the resource persons from INFLIBNET Centre and especially thanked Dr. Jagdish Arora, Director INFLIBNET Centre for his support and assistance in making the training programme successful and hoped such type of training programmes in collaboration with INFLIBNET Centre will be conducted in future also. Finally, Dr. Baba thanked all the hard working and dedicated Allama Iqbal Library staff who helped in one or other way to make this programme a great success. Certificates of participation were distributed to all the participants by Dr. Abdul Majid Baba, University Librarian, University of Kashmir.

## Onsite / In-house Training Programme on SOUL 2.0

### **Two-day In-house Training Programme on SOUL 2.0, T. C. College, Baramati, Pune, 12<sup>th</sup>-13<sup>th</sup> April, 2013**

Two-day in-house training on SOUL 2.0 software was organized by Anekant Education Society's Tuljaram Chaturchand College, Baramati in collaboration with INFLIBNET Centre on 12<sup>th</sup>-13<sup>th</sup> April 2013. Tuljaram Chaturchand College established in 1962, is a premier & pioneering college affiliated to University of Pune, having over 10,000 students. It's Library host more than 1,28,000 books and using SOUL software since 2006. Shri Kamlesh Vegad, Project Officer (LS) and Ms. Nabila Shaikh, SOUL Technical Assistant (CS), INFLIBNET Centre were resource persons. Dr. Chandrashekar Murumkar, Principal inaugurated the training programme. The

training programme was coordinated by Shri Amar Kulkarni, Librarian and Shri Dnyaneshwar Linge, Assistant Librarian, Tuljaram Chaturchand College. 16 participants attended the programme. Apart from training on all modules, SOUL 2.0 queries of library staff were resolved personally during this training programme.



*Shri Kamlesh Vegad, Project Officer (LS) and Ms. Nabila Shaikh, SOUL Technical Assistant (CS), INFLIBNET Centre along with the Participants of the In-house Training Programme on SOUL 2.0 at T.C. College, Baramati, Pune*



# MoU signed with Universities for Shodhganga and User Awareness Programme on Shodhganga

Shodhganga, a repository of Indian Electronic Theses and Dissertations, developed and managed by the INFLIBNET Centre has grown both in terms of number of theses deposited in the repository as well as number of universities who have signed MoU with the INFLIBNET Centre. As on 30<sup>th</sup> June 2013, 121 universities have signed MoU with the INFLIBNET Centre and numbers of theses in the repository have grown to more than 7,700. During the period under report, the following 9 universities signed MoU with the INFLIBNET Centre:

Sr.	Name of the University/ Institution	State	Date of signing MoU
1	Anna University, Chennai	Chennai	8 <sup>th</sup> April 2013
2	Maharishi Markandeshwar University, Mullana- Ambala*	Haryana	8 <sup>th</sup> April 2013
3	Hemchandracharya North Gujarat University, Patan	Gujarat	12 <sup>th</sup> April 2013
4	Symbiosis International University, Pune*	Maharashtra	3 <sup>rd</sup> May 2013
5	St.Peter's University, Chennai*	Tamil Nadu	21 <sup>st</sup> May 2013
6	Osmania University, Hyderabad	Andhra Pradesh	27 <sup>th</sup> May 2013
7	Ganpat University - Kherva, Mehsana*	Gujarat	4 <sup>th</sup> June 2013
8	Jaypee University of Information Technology, Solan*	Himachal Pradesh	5 <sup>th</sup> June 2013
9	International Institute of Information Technology, Hyderabad*	Andhra Pradesh	18 <sup>th</sup> June 2013

\* Not covered under Section 12 (B) of UGC Act (Not eligible for Financial Assistance)

The screenshot shows the Shodhganga website interface. At the top left is the Shodhganga logo with the tagline 'a reservoir of Indian theses'. The main navigation bar includes 'New User', 'Login as : Shodhganga User', 'University Coordinator', and 'Administrator'. The left sidebar contains a search box and a 'Browse' menu with categories like 'Universities & Departments', 'Issue Date', 'Researcher/Guide', 'Title', 'Keyword', and 'University'. The main content area features a 'Welcome to Shodhganga@INFLIBNET Centre' message, a 'Research in Progress' banner, and a '100+ Universities signed MoU' announcement. Below this, a list of 'Universities Contributed in Shodhganga [First 40 Universities]' is shown, including Cochin University of Science & Technology, Mahatma Gandhi University, and others. The right sidebar displays 'Update @ Shodhganga' with statistics: '107 Universities Signed MoU', '101 Universities started contributing...', and '602 Theses Received from Mahatma Gandhi University, Kottayam and 95 Theses Received from Sardar Patel University, Vallabh Vidyanagar'. A 'UGC Notification' box is also present at the bottom right.

### Signing of MoU on Shodhganga, Hemchandracharya North Gujarat University, Patan, 12<sup>th</sup> April, 2013

The Hemchandracharya North Gujarat University signed MoU with INFLIBNET Centre on Shodhganga on 12<sup>th</sup> April 2013 at Assembly Hall, Department of Hospital Management, Hemchandracharya North Gujarat University Campus, Patan. Dr. D M Patel, Registrar (I/C), HNGU exchanged the MoU for Shodhganga with Dr. Jagdish Arora, Director, INFLIBNET Centre in presence of Prof. Hemixa Rao, Vice Chancellor, Dr. Nidatt Barot, Pro Vice Chancellor, HNGU, Dr. D.T. Kapadiya, Vice Chancellor, KSV University and Shri Manoj Kumar K., Scientist D (CS), INFLIBNET Centre.

The Programme was started with prayer & lighting of lamp. Dr. Nishith Dharaiya, Life science Department, Hemchandracharya North Gujarat University welcomed the dignitaries on the dias as well as guests. MoU signing ceremony was organized by the Hemchandracharya North Gujarat University, Patan which witnessed signing

of five important MoUs, including MoU with INFLIBNET Centre. The other dignitaries, Shri Bharat Pathak, Director, GEER Foundation, Gandhinagar, Dr. Beena Patel, Head, R&D, Abellon Clean Energy Ltd., Dr. Neha Patel, Gujarat Cancer Society, Ahmedabad and Shri Rudresh Udad, Chief Officer, Patan Nagar Palika and Dr. Ajay Gor, Principal, Kadi Science College, Kadi were also present in the ceremony. Dr. D M Patel, Registrar (I/C) extended a warm vote of thanks



### User Awareness Programme on Shodhganga, Manonmaniam Sundaranar University, Tirunelveli, 14<sup>th</sup> May, 2013

One-day User Awareness Programme on Shodhganga was jointly organized by Manonmaniam Sundaranar University, Tirunelveli in collaboration with INFLIBNET Centre on 14<sup>th</sup> May 2013. Dr. A. Thirumagal, University Librarian, welcomed the Chief Guest, Vice-Chancellor,



*D M Patel, Registrar (I/C), Hemchandracharya North Gujarat University exchanged the MoU for Shodhganga with Dr. Jagdish Arora, Director, INFLIBNET Centre in presence of Prof. Hemixa Rao, Vice Chancellor, Dr. Nidatt Barot, Pro Vice Chancellor, Hemchandracharya North Gujarat University, Dr. D.T. Kapadiya, Vice Chancellor, KSV University and Shri Manoj Kumar K. Scientist D (CS), INFLIBNET Centre*





*Shri Manoj Kumar K., Scientist D (CS), INFLIBNET Centre along with the Participants of the User Awareness Programme on Shodhganga at Manonmaniam Sundaranar University, Tirunelveli*

Dean of Science and participants. Dr. A. K. Kumaraguru, Honorable Vice-Chancellor presided over the function and inaugurated the scholarly session with his inspired conversation. He encourages the research scholars to use e-content made available to University to update their knowledge. Dr. D. Pathinettan Padiyan, Dean of Science gave felicitation address. In his speech, he mentioned step-by-step development of tie up with the INFLIBNET Centre. Further, he mentioned that usage statistics of e-resources accessible to them has improved along with research output of the university. Mr. Manoj Kumar K., Scientist D (CS) was the resource person from INFLIBNET Centre. He gave "hands-on" training on "Shodhganga". He guided the students, about the process of uploading thesis into Shodhganga. Nearly 182 participants including research scholars and faculty members attended the awareness programme. Dr. K. Kannan, Assistant Librarian extended a warm vote of thanks at the end of session.



### **User Awareness Programme on Shodhganga, S.N.D.T. Women's University, Mumbai, 25<sup>th</sup> June, 2013**

One-day User Awareness Programme on Shodhganga was jointly organized by the INFLIBNET Centre and SNDT University on 25<sup>th</sup> June, 2013. Prof. Madhura Kesarkar, Director, Board of College and University

Development (BCUD) welcomed the guests and participants. She mentioned that University has signed an MoU with INFLIBNET Centre in August 2012 & submitted 73 theses into Shodhganga repository. Prof. Vandana Chakrabarti, Pro-Vice Chancellor inaugurated the programme. In her inaugural address, she mentioned that university is using Shodhganga for uploading and searching theses since the MoU was signed, but after this user awareness programme, it would be even more trouble-free and easy for university to upload theses themselves and use theses through Shodhganga. She mentioned that plagiarism software to be provided by the INFLIBNET Centre would help the university to become more alert on copying the contents of other researchers. Shri Manoj Kumar K., Scientist-D (CS), INFLIBNET Centre was the resource person for the training programme on behalf of

INFLIBNET Centre. Shri Manoj Kumar made a detailed presentation on "Shodhganga: A Repository of Indian Theses & Dissertation" and "Shodhgangotri: a Repository of Research in Progress". He guided faculty and scholars about access to various information and academic resources and discussed about how research work from India is used through Shodhganga repository from various countries i.e. Canada, Hungary etc. & acknowledged that how useful, they found it. Dr. Durga Murari, Deputy Librarian extended a warm vote of thanks. More than 50 participants including faculty members and research scholars attended the programme and sought clarifications about Shodhganga.



*Shri Manoj Kumar K., Scientist D (CS) INFLIBNET Centre along with the Participants of the Awareness Programme on Shodhganga at S.N.D.T. Women's University, Mumbai*

# INFLIBNET's New Initiative: A-View Virtual Classroom

INFLIBNET Centre has initiated virtual classroom every month using A-VIEW (Amrita Virtual Interactive E-learning World) classroom software developed by Amrita University to increase awareness about its services and activities as well as to address problems and issues that the users of our services may have.

A-VIEW Classroom is a framework that provides a rich interactive social environment for e-Learning. It is simple, user friendly video conferencing software, which provides a great opportunity to teach in "live" interactive mode to various geographical locations across India.

A-VIEW Classroom provides opportunity to connect several universities and colleges together and create a virtual world for institutes. It also acts as a Knowledge Cafe where one can discuss /chat about the lecture after the live class.

Using the A-VIEW classroom software, INFLIBNET Centre provides online information support to academic community in India. Scientists of INFLIBNET Centre interact with users in universities, colleges on various activities and functions of the Centre including N-LIST, UGC-Infonet Digital Library Consortium, SOUL, OJAS,

Union Catalogue (IndCat), Shodhganga and Shodhgangotri, etc. Lectures may also be arranged on topics of interest on demand from the user community.

To install A-VIEW software follow the instruction given below:

1. Register at <http://www.aview.in> with your email id. You will receive a confirmation mail from A-View Administrator.
2. After confirmation you can download a-view software.
3. Install it and start using it with username and password whenever a live session is "on" at INFLIBNET Centre.

Please send your Username to A-View Co-ordinator at INFLIBNET Centre ([divyakant@inflibnet.ac.in](mailto:divyakant@inflibnet.ac.in)) after completion of registration process.

For the details about lectures through A-View Software, kindly visit Calendar of INFLIBNET Centre of its web site <http://www.inflibnet.ac.in>.

JCCC@INFLIBNET | Licences and Fairuse | F A Q s | Contact Us | Contact Publisher

## UGC InfoNet Digital Library Consortium

INFLIBNET Centre  
An Inter University Centre of UGC



- Home
- About Us
- Members
- E-Resources
- How to Join?
- Operation
- UserGuide/help
- Troubleshooting
- E-RAMS
- Search
- Downloads

Welcome to Digital Library Consortium

### Access to E-resources on Additional IPs

Universities are encourage to purchase additional IP-based bandwidth from any Internet Service Provider (ISP) of their choice. E-resources accessible to you through IP addresses of BSNL, will also be made accessible on additional IPs assigned to you by your ISP. However, please ensure that you are buying IP-based Internet Bandwidth. Please note that **access cannot be provided on broad band Internet connectivity.**

[Current Members \(389\)](#) | [See details](#) | [Join](#)

[Guidelines for conducting User Awareness Programme](#) | [User Awareness Programme Report](#) | [NLIST:Extending e-resources to colleges](#)



### What's New ?

Access to Cell Press has been discontinued form January 2011 after subscribing to 10 subject collections ( includes half of Cell press and all LSR titles) of Elsevier's Science Direct. Please note that content from journals from Cell Press are available in open acces after one year.

[Access to Science Direct](#) 10 subjects (1. Biochemistry, Genetics & Mol. Biology, 2. Agriculture & Biological Science, 3. Chemistry, 4. Computer Science, 5. Economics, 6. Immunology & Microbiology, 7. Mathematics, 8. Physics & Astronomy, 9. Social Sciences, 10. Psychology) collection (1000+ journals titles) to 60 universities covered under UGCINFONET Digital Library Consortium from January 2011. **New**

[Access to Wiley 908 titles Universities covered under of](#)

[Join Mailing List](#)

© 2013 UGCINFONET Digital Library Consortium. INFLIBNET Centre, Gandhinagar, Gujarat, INDIA. feedback to [Webmaster](#) | [Disclaimer](#) | [Contact Us](#)

Last Updated (mm/dd/yyyy): 07/02/2013 16:24:40 - © INFLIBNET Centre

# 25th Meeting of the Governing Board, INFLIBNET Centre, Infocity, Gandhinagar

The 25<sup>th</sup> Meeting of the Governing Board was held at the new building of the INFLIBNET Centre in Infocity, Gandhinagar on 13<sup>th</sup> April, 2013.

This was the first meeting of the Governing Board held on the new Campus of the INFLIBNET Centre. The Meeting was held under the Chairmanship of Prof. N Mukunda, the newly appointed Chairman of the Governing Board. Moreover, the Governing Board also had a few new members who attended the meeting for the first time. These new members included: Prof. Rajan M Welukar, Vice-chancellor, University of Bombay; Prof. Ajit Kembhavi, Director, IUCAA, Pune; and Shri Upamanyu Basu, Financial Advisor, UGC.

All the members of the Governing Board were given a tour of the new building of the Centre. All members planted saplings of trees on the Campus. The Members and the Chairman felicitated the Director and staff for its new Building.

## Visit of the IUC Review Committee to the INFLIBNET Centre, 13<sup>th</sup> July, 2013

The IUC Review Committee, constituted by the UGC, is scheduled to visit the INFLIBNET Centre on 13<sup>th</sup> July, 2013 for performance evaluation of the Centre. The IUC Review Committee consists of the following members who would be visiting the Centre to evaluate its performance:

**Prof. Goverdhan Mehta,**  
**FNA, FRS**  
**National Research Professor**  
School of Chemistry  
University of Hyderabad  
Hyderabad  
**(Chairman)**

**Prof. M M Sharma**  
3, Jaswant Baugh (Runwal Park) Behind Akbarallys  
VN Purva Marg, Chembur Naka, Mumbai  
**(Member)**

**Prof. M Anandkrishnan**  
Main Road, Kasturibai Nagar  
Adyar, Chennai  
**(Member)**

**Prof. Surabhi Banerjee**  
**Vice-Chancellor**  
Central University of Orissa  
New Govt. Colony, Type-C, Block-4, Bhubaneswar  
**(Member)**

**Prof. Parasuraman S** **Member**  
**Director**  
Tata Institute of Social Science  
V N Purav Marg, Deonar, Mumbai  
**(Member)**

**Prof. M Durga Prasad**  
**Professor, Theoretical Chemistry**  
School of Chemistry  
University of Hyderabad  
Hyderabad  
**(Special Invitee)**

**Dr. (Mrs.) Renu Batra**  
**Jt. Secretary (IUC)/MC**  
University Grants Commission  
Bahadur Shah Zafar Marg  
New Delhi  
**(UGC Representative)**

New editions of brochures, leaflets and pamphlets on the activities carried out by the Centre are being published. Arrangements are being made to receive the Committee and make a presentation on our activities, services and problems that the Centre is facing on various issues relating to manpower, funding, promotion, avenues for staff etc.



# Schedule of forthcoming Workshops/Trainings at INFLIBNET Centre

Sr No	Date	Programme
1	12th August, 2013	Workshop on Optimizing the Potential and Impact in Research Publishing at INFLIBNET Centre
2	2nd to 6th September, 2013	SOUL 2.0 Training Programme
3	7th -11th October, 2013	SOUL 2.0 Training Programme
4	28th oct. - 1st Nov., 2013	SOUL 2.0 Training Programme
4	18th - 22nd November, 2013	IRTPLA
5	25th -29th November, 2013	SOUL 2.0 Training Programme
6	2nd - 6th December, 2013	DSpace/Research Methodology
7	16th - 20th December, 2013	SOUL 2.0 Training Programme
8	30th December 2013 to 3rd January 2014	IRTPLA

**IndCat: Indian Catalogue**  
Online Union Catalogue of Indian Universities

Home | About (Union Catalogue) | Book (Database) | Thesis (Database) | Serial (Database) | e-Video (CEC Video) | OCS (Online Copy-Catalogues) | Join IndCat (Participation / Contribution)

**IndCat**  
Union Catalogue of Indian Universities

IndCat is unified Online Library Catalogues of books, theses and journals available in major university libraries in India. The union database contains bibliographic description, location and holdings information for books, journals and theses in all subject areas available in more than 157 university libraries across the country.

[Read more](#)

Search:  Keytitle

IndCat: Current Status		
Database	No of Records	Institutes
Book	1,28,04,667	158
Thesis	2,53,071	237
Serial	35,209	256
E-Video	14,909	17*

**Participation**

- Central Universities
- State Universities
- Deemed Universities
- Institutions of National Importance
- Other Institutes / Universities

**Login Zone**

University / Institute:  Select University   
 Password:   
 Code:  25247

[Browse by Key Title »](#)

A | B | C | D | E | F | G | H | I | J | K | L | M | N | O | P | Q | R | S | T | U | V | W | X | Y | Z |

# Visitors

- ❖ **Prof. N. Mukunda,**  
Chairman, Governing Board, INFLIBNET Centre
- ❖ **Prof Ajit Kembhavi,**  
Member, Governing Board, INFLIBNET Centre
- ❖ **Dr. Kuncheria P Isaac,**  
Member Secretary, AICTE, New Delhi
- ❖ **Prof. R K Kale,**  
Vice Chancellor, Central University of Gujarat,  
Gandhinagar
- ❖ **Dr R K Chadha,**  
Additional Secretary, Lok Sabha, New Delhi
- ❖ **Prof J P Gupta,**  
Vice Chancellor, Sharda University, Noida
- ❖ **Dr Rajan M Velukar,**  
Vice-chancellor, University of Bombay, Mumbai
- ❖ **Prof Jai Rup Singh,**  
Vice-chancellor, Central University of Punjab,  
Bathinda
- ❖ **Shri R S Mani,**  
Scientist-F, NIC, New Delhi
- ❖ **Dr. Upamanyu Basu,**  
PRS, Financial Advisor, UGC



An MHRD Project under its National Mission on Education through ICT (NME-ICT)

**A Gateway to All Post Graduate Courses**

Home
Student Corner
Uploaded Content
NME-ICT (MHRD)
Other Open Learning Links
Contact Us



The MHRD, under its National Mission on Education through ICT (NME-ICT), has assigned work to the UGC for development of e-content in 77 subjects at postgraduate level. The content and its quality is the key component of education system. High quality, curriculum-based, interactive content in different subjects across all disciplines of social sciences, arts, fine arts & humanities, natural & mathematical sciences, linguistics and languages is being developed under this initiative named e-PG Pathshala.

NOTIFICATIONS « » **A National Workshop for the National Coordinator and Subject Coordinator**

**e-Content in-Progress**

sep 10, 2012 at New Delhi

A National Workshop for the National Coordinator and Subject Coordinator

Workshop for the Paper Coordinator of Sociology on Sep 15, 2012 at New Delhi

**Login**

**Course / Subjects @ ePathshala**

<ul style="list-style-type: none"> <li>■ <a href="#">Anthropology</a></li> <li>■ <a href="#">Biotechnology</a></li> <li>■ <a href="#">Chemistry</a></li> <li>■ <a href="#">Computational Sciences</a></li> <li>■ <a href="#">Computer Science</a></li> <li>■ <a href="#">Economics</a></li> <li>■ <a href="#">English</a></li> <li>■ <a href="#">Food Technology</a></li> <li>■ <a href="#">Geography</a></li> </ul>	<ul style="list-style-type: none"> <li>■ <a href="#">Biochemistry</a></li> <li>■ <a href="#">Botany</a></li> <li>■ <a href="#">Commerce</a></li> <li>■ <a href="#">Computational Social Science</a></li> <li>■ <a href="#">Earth Sciences</a></li> <li>■ <a href="#">Education</a></li> <li>■ <a href="#">Environmental Sciences</a></li> <li>■ <a href="#">Forensic Science</a></li> <li>■ <a href="#">Hindi</a></li> </ul>
--	--

**Inviting Proposal-NEW e-PG Pathshala**

- [Project Guidelines](#)
- [Project Proposal](#)
- [Team](#)
- [Syllabus](#)

**Downloads**

- [Guidelines for e-PG Pathshala](#)
- [Memorandum of Agreement \(MoA\)](#)
- [Guidelines for Content Writers](#)
- [Input template: e-Text, Learn More \(optional\)](#)

## Building the State-of-the-Art IT Infrastructure for ICT enabled Higher Educational Institutions

\*Manoj Kumar K, Scientist-D (CS) and Head, NQC

Strength and quality of a higher education institute leverage on the state-of-the-art IT infrastructure which works as the technical backbone for the activities carried out by the institute and skilled manpower to handle the IT services of the Institute. Planning, analysing, designing, implementing and testing of such low voltage IT solutions which covers networking with virtualisation switches and structured gigabit cabling, IP telephony, Building Management System (BMS), sophisticated Data Centre with high-end servers, UTM, Public Addressing System, Surveillance System, Video conferencing etc. are challenging tasks. This article introduces the concept of various components required for such a planning, designing and implementation of such a low voltage IT Solution.



### 1. Introduction

Dedicated and sophisticated Information Technology (IT) are basic ingredient as well as basic infrastructure requirement for the overall development of a modern organisation. Activities in an educational institutions leverage on the ICT set up to deliver services and educational content to the students, faculty members and research scholars. Paradigm shift in the use of services of ICT for teaching and learning is of paramount importance for interaction and knowledge generation. Entry of computers in 1980s into the organisations and its use in education have paved way for many automated tasks as well as service re-engineering in educational institutions. Introduction of network and Internet has multiplied the speed and accuracy of information reach and sharing. Network setup is a critical component in an organisation with dedicated bandwidth for the users and seamless access to the resources available on Internet. To make use of proper IT services, Institutes have to be equipped with sophisticated ICT equipment and specialized devices within affordable budget of the organisation. Energy saving is a global concern and use of old and outdated equipment would not only cause the energy loss but also lead towards serious health hazards. In order to meet the requirement of users, organisation has to judiciously plan its ICT requirement and infrastructure based on the budget, trends in latest

technology, economical and technical feasibility. This paper discusses network requirement and design of ICT infrastructure, in general, for a higher education institution and implementation of such a solution as a case study at INFLIBNET Centre in its new building near to Infocity, Gandhinagar, Gujarat.

### 2. State-of-the-Art Data Centre

Creation of content and hosting it in a secured place, with access privileges for different levels of users, is a challenging task. Any educational institution would prefer to host its own content in its campus and preserve it by protecting it from external as well as internal threats. Normal PCs and laptops are sufficient for day to day work of users, but prone to hardware failures and other

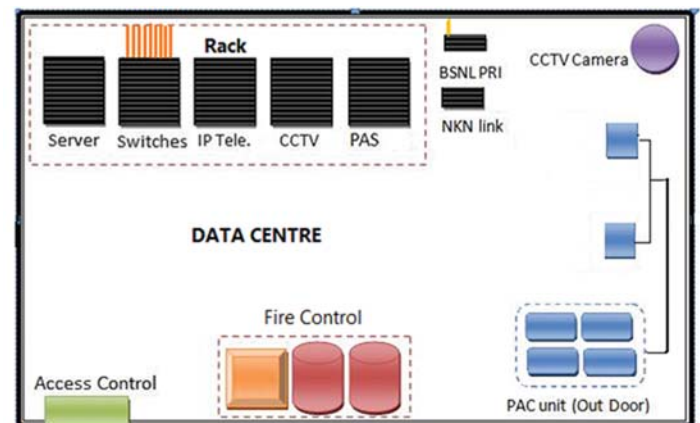



malfunctioning errors. Data is to be secured and shared for effective use. As such, computers called “servers” are required as centralized computers to store common services and data storage. Apart from its relatively high configurations in terms of memory, processor, storage etc, servers should also have redundancy in power and processor, provision for data storage and backup, tailor-made access policies for the users, sharing of common resources etc. Many small servers can be stacked together in a chassis with common redundant power supply, shared Internet connectivity and storage units. One such stacking of servers are called blade servers. Blade servers are classified depending upon the size of the rack such as 1U, 2U, 7U and as large as 14 U. Number of servers depends on the unit size, a 7U chassis can accommodate 7-8 servers.

All these servers, devices and computers are to be placed in a dedicated and protected environment called Data Centre. To define uptime of data centre, Tier-3 standardized methodology is used for designing to provide optimum performance, feasible investment and ROI (return on investment). Data centre at INFLIBNET Centre is designed as the most robust setup and less prone to failures and also to host mission critical servers and computer systems, with fully redundant subsystems, wherever possible, such as cooling, network links, storage, etc. and compartmentalized security zones controlled by biometric access controls methods. All components are fully fault-tolerant including uplinks, storage, chillers, HVAC systems, servers etc. Everything is to be dual-powered in a Tier 4 standard data centre.

## 2.1. Modular Servers and Chassis

Modularity is the keyword when it comes to server design in contrast to traditional stand alone servers. Modular server is a blade system consists of modular server chassis



*HP Blade Server C3000*

with enclosure computer blades, and integrated storage area network (SAN) and three to five service modules. The service modules are storage control module, Gigabit Ethernet switch module and chassis management. These are in addition to its own motherboard and processors. Storage control module support RAID (Redundant array of Independent Disks) and manages RAID partitions of the HDDs in the integrated bay. These kinds of servers are sufficient for educational institutions with 100 to 500 faculty members. Few popular modules of chassis available in the market are Blade Centre (S, E, H, HT) of IBM, Blade System (C3000, C7000, x..x..) of HP, Power Edge of Dell, UCS 5108 of Cisco.

The INFLIBNET Centre uses HP Blade System C 3000 Enclosure for hosting Web Services, INFLIBNET website, Shodhganga, OJAS, NLIST, InfoPort, e-PG Pathshala, IndCat, DNS server, Intranet server, etc. IBM Blade Centre S chassis is used for Web co-location services at BSNL, which host mirror sites of INFLIBNET Centre for the services such as UGC website, NLIST Proxy Server, Online UGC Scholarship scheme and other important services.

## 2.2 Virtual Core Switching Technology and Intelligent Edge Switches

The core switches have to be selected based on design principles which support virtualization, efficient power and cooling, hi-density and scalability for efficient data centre infrastructure growth and designed for enhanced manageability, comprehensive security, delivery optimization, fault tolerant, and later, need to optimize network infrastructure. Virtual core switching technology at INFLIBNET Centre is used in the data centre for increase bandwidth, reduce complexity and create an active mesh between server and switches in the LAN.

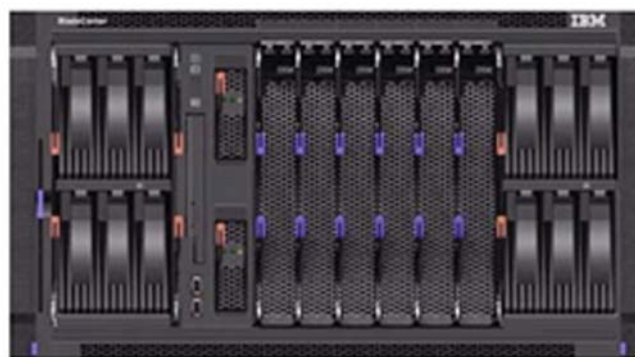

*IBM Blade S Chassis S*

Layer 2 based edge switches (ie. CISCO Catalyst 2960s) are used in INFLIBNET's Data Centre to improve security, sustainability and borderless network experience which include new flex and data stacking capability provides a unified data plane, configuration, and single IP address management for a group of switches with 1 to 100 Gigabit of throughput connectivity and PoE+ (Power over Ethernet Plus) by offering fast Ethernet access connectivity and removes the need for wall power to each PoE-enabled devices. These switches also support Virtual Local Area Network (VLAN) and DMZ (demilitarized zone) between private network and the public network through UTM.

### 2.3. Structured cabling backbone network (CAT 7A & Optical Fiber)

The INFLIBNET Centre would be using structured cabling with 40G ready network, 100G road map

backbone network built with CAT 7A and Optical Fiber wiring that can carry and accommodate data, voice, multimedia, security data, VoIP, PoE and wireless connections throughout the building in the campus. There are two areas in the Centre vis-a-vis technical / administration block and residential blocks. Well planned and designed CAT 7A structured cabling backbone network system empower performance of up to 1000 MHz continuous flow of information, support the sharing of resources and promotes smooth operations. Optical Fiber uplinks would be used to connect various Switch rooms. The whole network will be centralised on a core switch (ie. CISCO NEXUS 7004) to manage its network operations. The switch offer high-density 10, 40, and 100 Gigabit Ethernet with application awareness and comprehensive performance analytics for the data centre. It would also deliver high performance and density for core, aggregation, end-of-row, and top-of-rack server deployments in a highly

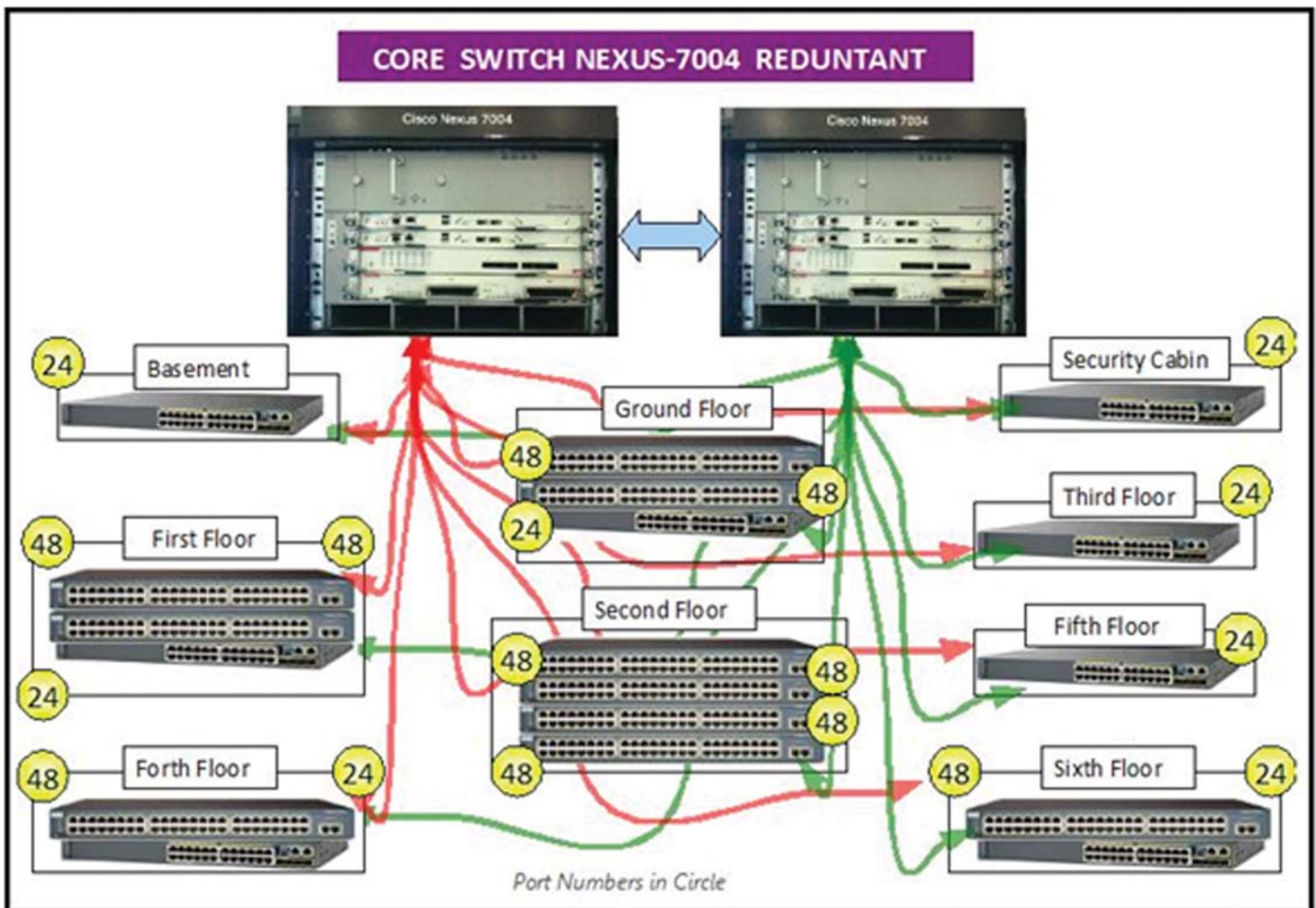

Schematic diagram showing Core and Edge switches distributions in all 7 floors in INFLIBNET Centre

resilient modular platform. A switch which is designed for the most mission-critical enterprise and service provider data centre deployments is chosen for the INFLIBNET Centre. Core switch and edge switches distribution are shown below in a schematic diagram:

## 2.4. Firewall and UTM

The INFLIBNET Centre is proposed high-performance and reliable Unified Threat Management (UTM) as Firewall equipment. The firewall proposed is a UTM based firewall equipment from FortiGate which has built-in hardware and software that helps to screen out the network with the fastest firewall technology to provide protection from hackers, viruses, and worms over the Internet and dynamic network environment. Firewall is also capable of Layer 4 functionality of the OSI Model, which are capable of packet-forwarding and identifying which application protocols are included with each packet, and it uses this information to send the packet to appropriate client/node and also provide an effective security and flow control by traffic filtering and forwarding the packets.

The INFLIBNET Centre host lots of important services as mention above which need security protection against attackers/hackers and vulnerabilities in OS and software. By default, 65,535 ports are opened for various services and applications in computers including servers. Services and data transmissions are to be closely monitored, patch up and timely updates are to be done at regular intervals in protected network location under port controlled security tools. The hosting server placed in a zone call DMZ (Demilitarised Zone) area by creating virtual hosts with private and local IPs. The Firewall technologies proposed has an integrated high performance protection system against wide range of threats, creating VPN technology, ensuring data privacy between multiple networks and host using SSL VPN protocols, Anti-Virus, Web application filtering, Intrusions Detection and Prevention System (IDS/IPS), anti-spam and traffic shaping to deliver multi layer security.

## 3. IP Telephony

IP Telephony system at INFLIBNET Centre is an Internet Protocol (based) phones, which can help to improve

## INFLIBNET Data Centre IP Telephony Connectivity

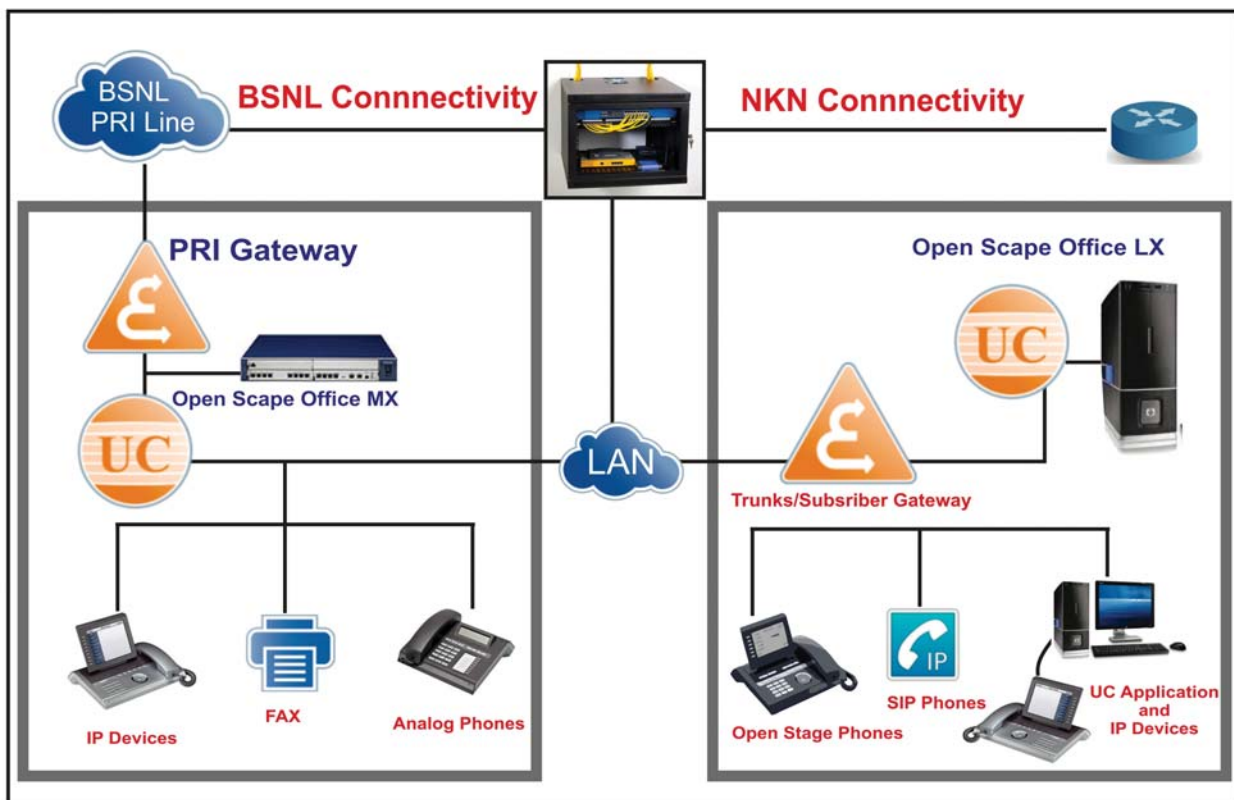

Schematic diagram showing the IP Telephony System @ INFLIBNET Centre





OpenStage 60



OpenStage 40



OpenStage 15

productivity of telephony services with specialised software and hardware. Hardware based systems use a regular phone instrument to be used as Internet phones. Software system provides IP phone service through an application that allows phone calls to be made from any computer with a sound card. The whole telephone system is part of low voltage solution offered by M/s Siemens to INFLIBNET Centre. It uses proprietary software called 'My portal' which is installed in all PCs connected with IP phones through RJ 45 connector and Ethernet cables.

by the Centre. NKN is established by National Informatics Centre with technical support of Powergrid. STM (Synchronous Transfer Mode) equipment at Centre is connected through Fiber to Gandhinagar node of NKN on ring topology. This gives redundancy of NKN links and the architecture of the NKN is enabled to reach all universities with minimum hops. As shown in figure above, any university can be reached with minimum nodes on NKN and this gives INFLIBNET an advantage of serving the universities with speed and higher data transfer.

The INFLIBNET Centre use three different categories of phones i.e. Siemens Open Stage 60 for Scientists, Open Stage 40 for other staff member and Open Stage 15 for security & residences. This OpenStage family phones are designed to be user-friendly and simplify implementation. Sensorial interfaces based on advanced technology solutions (touch keys, embedded color LEDs, touch slider for volume control and touch guide navigator) as well as large, tiltable, backlit color graphical displays in TFT technology facilitate user interaction.

#### 4. Gigabit bandwidth under NKN

The INFLIBNET Centre is connected to the National Knowledge Network (NKN)/NME-ICT project that provides 1 Gbps MPLS (Multi Protocol Layer Switching) connectivity to all universities in India. The bandwidth is currently restricted to 100-150 Mbps, but it can be increased on demand based on bandwidth intensive application upto 1 Gbps. INFLIBNET Centre is having two Internet connections i.e. one from NKN and other from BSNL for standby purpose. This gives redundancy to Internet links which is essential in an organisation which has a Tier 3 Data Centre. It is ensured that access to e-resources is enabled on all sets of IP addresses used

### NKN Connectivity

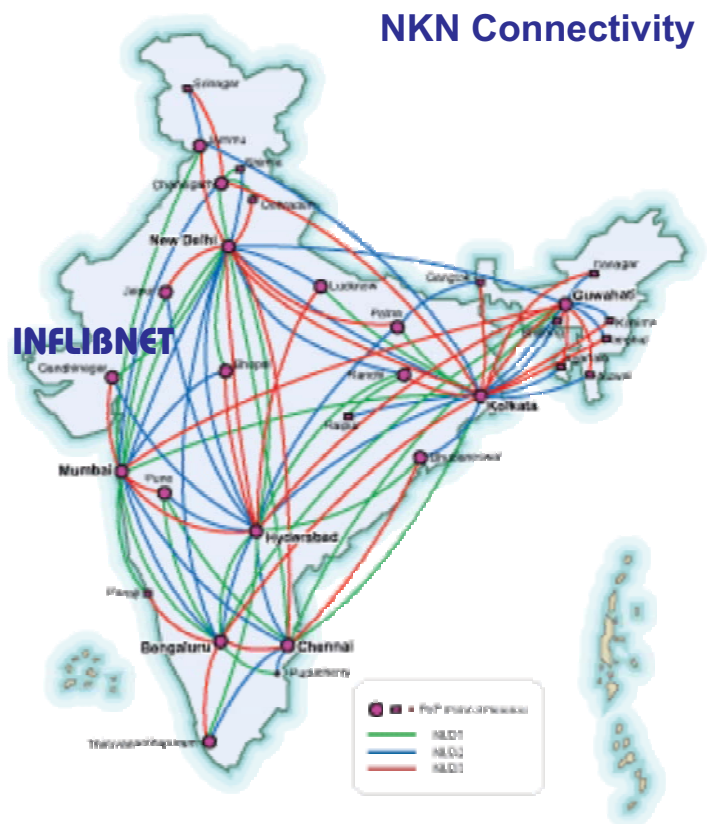

## 5. Building Management System (BMS)

Energy conservation and the management is a global issue to be tackled at various levels in a organisation with proper planning and energy can be optimally saved which can lead to "Green Building" and the design perspective of a building should leverage on IT infrastructure requirement. Building Management System (BMS) integrates the mechanical and electrical equipment used for various services such as ventilation, lighting, power system, fire system and security system. BMS consists of software and hardware in a computer-based control system installed in a building that controls and monitors the above mentioned equipment. INFLIBNET Centre uses HVAC (Heating, Ventilation and Air Conditioning) for indoor environmental comfort based on the principle of thermo dynamics, fluid mechanics and heat transfer, ensuring maximum levels of efficiency and economy. This is achieved by maintaining the optimum balance between environmental conditions, energy usage and operating requirements. a DDC controllers (Digital Direct Controls) distributed with field devices such as voltage sensors, temperature sensors, smoke dictators, fire dictators, etc. INFLIBNET Centre uses Honeywell Trend for the BMS Solutions.

## 6. Surveillance System using CCTVs

Surveillance is the monitoring of the activities, behavior and other field conditions for managing, directing or protecting employees as well as outsiders. This is done generally by observing with the use of an electronic equipment such as CCTVs (Closed-Circuit Television) cameras. This also helps to maintain the security of the building. CCTV cameras are generally attached to a storage device which can archive video captures of all cameras and preserve it for later use. The number of CCTV cameras to be used depends upon the size, magnitude, layout and orientation of the building. 28 CCTV cameras from M/s. Honeywell are proposed by categorizing into three types. PTZ security cameras allow to control the Pan, Tilt and Zoom operations of the camera lens remotely or through programming. PTZ camera have ability to move up, down, right, left and even zoom. Other two cameras are Box types cameras and Dome type cameras. Dome cameras are usually installed indoor which has IR facility for night vision. Box cameras are not generally IR sensitive. All cameras proposed are IP-based, advanced and PoE (Power on Ethernet) enabled.



## 7. Audio-Video Integration and Public Addressing System (PAS)

A Public Addressing System (PAS) is required in various places in any organisation. Soothing music played lightly in the background in the premises of a building would give pleasant ambiance for working professionals. Such audio should have centralized control for the sound management and local control to mute the music in silence zones, if required. The entire building can be divided into various zones. Zone wise announcement is also possible with centralized control. In addition to audio, video conferencing and video projectors are also important in an organisation to deliver video content remotely and locally. The technology should be able to

control light, sound, video projection in an integrated environment by using a touch panel. Remote controlled pop-up projection screen, windows curtain controller, touch sensitive and sound activated microphone and a pop-up box fitted on the table with HDMI, VGA port, USB port, Ethernet socket, etc. could be made available for each speaker. Boardroom integrated solution with all these facilities can be controlled with a wireless touchpad/i-Pad in conference rooms and meeting rooms.

A well-equipped auditorium having professional sound system with an advanced dynamic mixer is yet another necessity. As such, auditorium of INFLIBNET Centre is equipped with professional sound system with premium ultra high headroom analog mixer and state-of-art mic preamps with DSP with 100 presets including reverb, chorus, flanger, delay, pitch shifter and various multi effects with atleast 12 channels for audio devices like mics (i.e. collar, hand-help, audio mike, cordless and vocal instrumental), laptop, CD/DVD player or music instruments, media players, etc. The mixer is connected with sufficient amplifiers for Base (Woofers), FOH (Front of the House), surround speakers, cross over amplifier for balancing the gain of audio and stage monitor speaker with plug and play facility. The auditorium would also be equipped with Wi-Fi hotspot.

This audio system would be synchronized with proper video projection facility having high quality projector (7000+ ANSI luminance, ceiling mounted projector with remote controlled dropdown lift). The motorised projection screen is wide enough (22 x 12 ft) to display the video projection for the clear view of all the people from various angle in the auditorium.

## 8. Video Conferencing Facility

Now a day, it is essential to communicate with other institutions not only on data transfer mode but also video mode. If an institutes is having high Internet bandwidth such as NKN, desktop video conferencing is possible. It is desirable to have a dedicated to video conferencing setup with sound proof room to have multi party conferencing. The same set up in an academic institution can also be used for delivering live video lecture. For these purposes, a dedicated ISDN PRI line or shared lease line with dedicated bandwidth (min. 384 kbps) can be used. High definition resolution camera with codec, multi point control unit and HD LCD/LED TV for display.

## 9. Conclusion

The INFLIBNET Centre designed and planned the ICT requirements based on the requirements and objectives of the Centre. In order to get competitive price, all IT related components are integrated and placed order is placed to a System Integrator for effective integration work for passive and active state-of-the-art low voltage infrastructure solution for the INFLIBNET Centre's new building at Infocity, Gandhinagar. As discussed above, the solution includes layer 3 core switching with virtualisation and 40G/100G ready network with POE+ edge switches along with 10G uplink, IP telephony with high and mid range of IP phones, surveillance system, boardroom solutions, public addressing system & AV solution, high resolution video conferencing solution, state-of-the-art auditorium, visitor management system, dedicated and sophisticated tier-3 Data Centre with precision A/C, CAT 7A cabling with OM4/OM2 Grade Fibre, Building Management System (BMS) with automated fire detection, fire suppression, access control, biometric access control, sophisticated UTM (Unified Thread Management System).

State-of-the-art IT infrastructure depends upon the state of the institutions, its objective, requirement and available budget. It also levy upon the technical prowess who plan and design it. Proper planning, aggressive market survey of available products, keeping abreast with the technology trends, time scheduling of execution of each task and coordination with the architect/contractor of the building are some of the important parameters to be considered before planning and designing the IT infrastructure for an institution. Demands from academic community for seamless access to the knowledge databases and e-resources are increasing day-by-day. New technologies and solutions are introduced in the competitive market. The scalability of such a infrastructure for next 10 years is to be assured without much technical changes and financial constraints.

---

*\* The author is heading the Network Division in the Centre*

*Note: 'Pictures shown in this article are from the companies who supplied the products /services and used for representational purpose only. Organisations are requested to explore products of all companies to decide on best features and cost effective solutions'.*



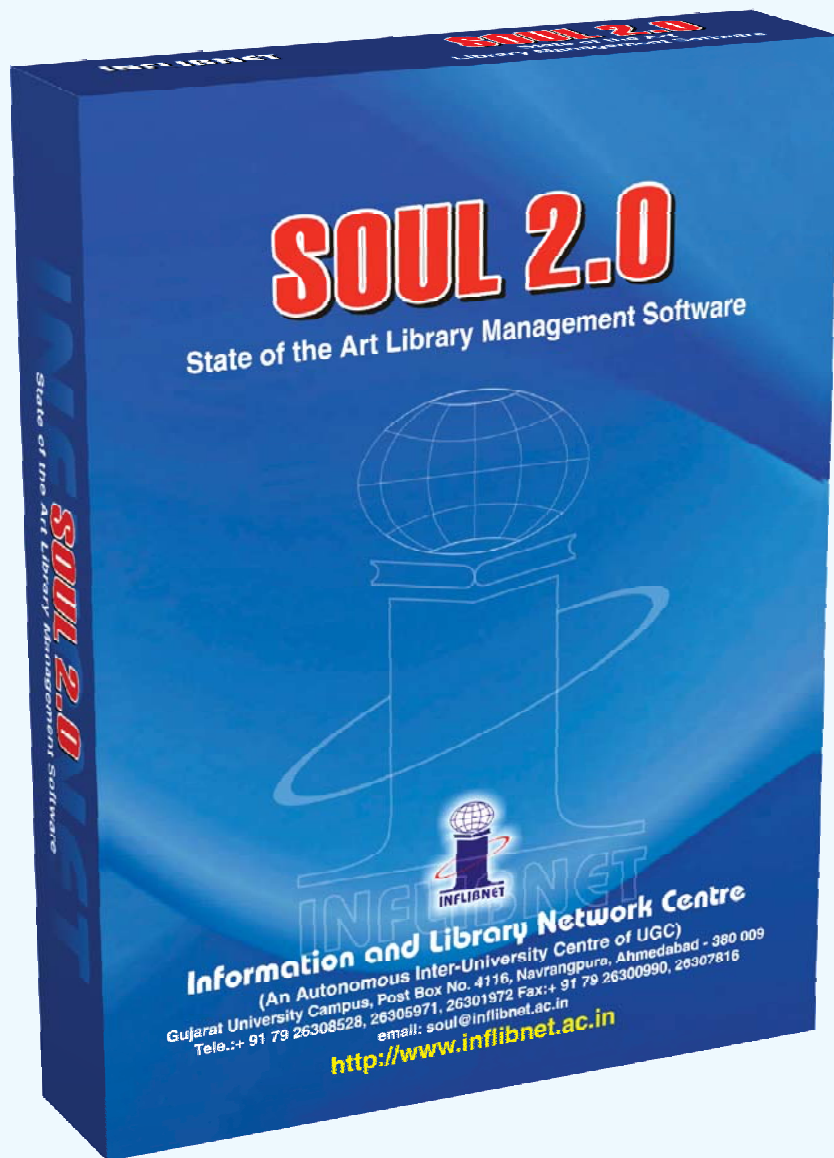

# SOUL 2.0

STATE-OF-THE-ART INTEGRATED  
LIBRARY MANAGEMENT SOFTWARE

<http://www.inflibnet.ac.in/soul>

# New Appointment

## Sahana Munshi, Section Officer ( P & S)



Smt. Sahana Munshi joined the INFLIBNET Centre on 18th June 2013 as Section Officer (P&S). Prior to her present assignment, she has served the INFLIBNET Centre as Personal Assistant since 1991. She is working with administration since 2001 and was worked as In-Charge, Purchase & Stores Division from Aug 2012 onwards. She has completed her graduation in commerce and obtained Master's Degree in Library and Information Science. She has acquired Post Graduate Diploma in Human Resource Management from Bhavan's, Ahmedabad.

**Information and Library Network Centre**  
An Inter-University Centre of University Grants Commission (UGC)  
Gandhinagar Gujarat

सूचना एव पुस्तकालय नेटवर्क केन्द्र

हिंदी संस्करण  
Sunday, October 20, 2013.  
-Select Search Option-

A Gateway to India's Academic and Research Community

About Us | Functional Groups | Services | Publications | Library | N-LIST | Shodhganga | OJAS | INFOPORTAL | R T I | Check Mail | Links | e-Pathshala

Welcome to INFLIBNET Centre

Information and Library Network (INFLIBNET) Centre [www.inflibnet.ac.in] is an Autonomous Inter-University Centre (IUC) of University Grants Commission (UGC) involved in creating infrastructure for sharing of library and information resources and services among Academic and Research Institutions. INFLIBNET works collaboratively with Indian university libraries to shape the future of the academic libraries in the evolving information environment.

**Events Calendar**

« October 2013 »

S	M	T	W	T	F	S
	1	2	3	4	5	
6	7	8	9	10	11	12
13	14	15	16	17	18	19
20	21	22	23	24	25	26
27	28	29	30	31		

**Forthcoming Events**

- ETD 2015: 18th International Symposium on Electronic Theses and Dissertations [more details...](#)
- Attachment Training Programme for Practicing Librarians and Computer Professionals of North Eastern Region [more details...](#)

**Events Archives**

**Vidwan: Experts Database:** Update your profile | **N-LIST:** e-res to colleges | University Directory | **e-Education**  
**More@INFLIBNET:** Open Journals Access System (OJAS) | Virtual Classroom | Weblog | Chat | Forum | GujCat | CVRS

**Latest@INFLIBNET**

The INFLIBNET Centre was awarded **Jury Choice Award e-INDIA 2011** in the category "Digital Learning through ICT in Higher Education Institute" for the Year 2011 for the project entitled **Shodhganga: a Repository of Indian Theses**

SATKAL Life Time Achievement Awards to Dr Jagdish Arora, Director, INFLIBNET Centre.

Video Gallery | Jobs | Tenders | SOUL 2.0 Updates  
SOUL helpline: 079-2326-8300 (9:30AM -6:00PM)  
[Mailing List@INFLIBNET Centre]

Intranet Web@INFLIBNET  
INFLIBNET Centre@News

About Us | Functional Groups | Services | Publications | R T I | Library | N-LIST | Shodhganga | INFOPORTAL | OJAS | Links | Downloads | Hindi Version  
© 2013 INFLIBNET Centre, Gandhinagar, Gujarat, INDIA. feedback to Webmaster | Disclaimer | Contact Us

Last Updated (mm/dd/yyyy): 10/12/2013 09:10:55 - © INFLIBNET Centre]

## Alama Iqbal Library one of the best in country: Prof Talat



**Srinagar, June 19: (GNS)** With an aim to expedite the process of Library Automation in the State of Jammu and Kashmir Allama Iqbal Library, University of Kashmir in collaboration with Information and Library Network (INFLIBNET), Gandhinagar, Gujarat today started a five days INFLIBNET Regional Training Programme in Library Automation (IRTPLA) for library professionals.

While inaugurating the training program Vice Chancellor University of Kashmir Prof Talat said the process of automation is the need of the hour in the libraries all over the world "as people today prefer to access the research material, journals and books on-line".

"There is a great need for updating and expediting the process of automation in our libraries as the problem of housing the ever increasing number of books, journals and research material is being faced by library professionals and educational institutions all over the world due to space constraints and our case is no different," Prof Talat said.

While appreciating the efforts of the Allama Iqbal Library staff for providing various facilities in the form of consultancy services and training programmes to other libraries of the State, Prof Talat said Allama Iqbal Library is ranked as one of the best in the country. "It is due to the efforts of the staff and other personnel who work here that we have achieved this feat but we do not have to be complacent with this and ensure that our resources are equally accessed and used by scholars, students and teachers of various colleges and other stakeholders in the society so that they could get benefitted by the rich collection sources at our library."

## மனோன்மணியம் சுந்தரனார் பல்கலைக்கழகத்தில் பயிற்சி

நெல்லை, மே.19-

நெல்லை மனோன்மணியம் சுந்தரனார் பல்கலைக்கழக ஆட்சிமன்ற குழு அரங்கில் இன்பிளிப்நெட் அமைப்பு சார்பில் ஒரு நாள் பயிற்சி முகாம் நடந்தது. பல்கலைக்கழகத்தில் உள்ள முனைவர் பட்டம் பெற்றவர்களின் ஆய்வு கட்டுரைகளை கணினி மூலம் இணையதளத்தில் பதிவேற்றம் செய்வது பற்றி பயிற்சி அளிக்கப்பட்டது. இதன் மூலம், முனைவர் பட்ட மாணவர்கள் தங்கள் ஆய்வை தொடங்

குவதற்கு முன், இதுவரை ஆய்வில் மேற்கொண்ட ஆய்வுகளின் தொகுப்பை இலவசமாக காணலாம். கே.மனோஜ் குமார் பயிற்சியில் கலந்து கொண்ட நூலகங்கள், ஆராய்ச்சியாளர்கள், மாணவர்கள் மற்றும் ஆசிரியர்களுக்கு பயிற்சி அளித்தார். நிகழ்ச்சிக்கு பல்கலைக்கழக துணை வேந்தர் ஆ.குமரகுரு தலைமை தாங்கினார். அறிவியல் புல முதன்மையர் பதினெட்டாம் படியான் பேசினார். உதவி நூலகர் நன்றி கூறினார்.

## KU VC Inaugurates IRTPLA Regional Training Program

Published: June 19, 2015 | 0 comments

CAMPUS REPORTER

Srinagar - With an aim to expedite the process of Library Automation in the State of Jammu and Kashmir Allama Iqbal Library, University of Kashmir started a five days INFLIBNET Regional Training Programme in Library Automation (IRTPLA) for library professionals in collaboration with Information and Library Network (INFLIBNET), Gandhinagar, Gujarat which began here at KU on Tuesday.

While inaugurating the training program Vice Chancellor University of Kashmir Prof Talat said that the process of automation is the need of the hour in the libraries all over the world "as people today prefer to access the research material, journals and books on-line"

"There is a great need for updating and expediting the process of automation in our libraries as the problem of housing the ever increasing number of books, journals and research material is being faced by library professionals and educational institutions all over the world due to space constraints and our case is no different," said Prof Talat.

While appreciating the efforts of the Allama Iqbal Library staff for providing various facilities in the form of consultancy services and training programmes to other libraries of the State Prof Talat said "Our library is ranked as one of the best in the country and it is due to the efforts of the staff and other personnel who work here that we have achieved this feat. But we do not have to be complacent with this and ensure that our resources are equally accessed and used by scholars, students and teachers of various colleges and other stakeholders in the society so that they could get benefitted by the rich collection of resources at our library."

Prof Talat also thanked INFLIBNET (an Autonomous Inter-University Centre (IUC) of University Grants Commission (UGC) for their support.

**INFLIBNET**  
in Regional News





## **Information and Library Network Centre**

(An Autonomous Inter-University Centre of UGC)

Infocity, Gandhinagar - 382007, Gujarat, INDIA  
Email:director@inlibnet.ac.in

<http://www.inlibnet.ac.in>

(For Private Circulation Only)